





testo 890 · Thermal imager

Instruction manual



1 Contents

1	Contents	3
2	Safety and the environment.....	5
	2.1. About this document.....	5
	2.2. Ensure safety.....	6
	2.3. Protecting the environment.....	7
3	Specifications	8
	3.1. Use	8
	3.2. Technical data	9
4	Product description.....	16
	4.1. Overview.....	16
	4.1.1. Product components.....	16
	4.1.2. Display interface	18
	4.1.3. Operating concept	20
	4.2. Basic properties.....	21
	4.2.1. Power supply	21
	4.2.2. File formats and file names.....	22
5	First steps	23
	5.1. Commissioning.....	23
	5.1.1. Connecting the rechargeable battery	23
	5.1.2. Performing basic settings.....	23
	5.1.3. Initial charging of the rechargeable battery	25
	5.2. Getting to know the product.....	26
	5.2.1. Adjusting the hand strap	26
	5.2.2. Attaching the lens cover to the hand strap	27
	5.2.3. Rotating the handle.....	27
	5.2.4. Attaching a shoulder strap	28
	5.2.5. Using a lens case	28
	5.2.6. Inserting the memory card	29
	5.2.7. Fitting/removing IR protection glass.....	29
	5.2.8. Changing the lens.....	30
	5.2.9. Switching the imager on/off.....	31
	5.2.10. Manually focusing the image.....	31
	5.2.11. Automatically focusing the image.....	32
	5.2.12. Recording (freezing/saving) an image.....	32

6	Using the product	33
6.1.	Menu bar/tabs	33
6.1.1.	 Analysis functions tab	33
6.1.2.	 Scale and correction functions tab	33
6.1.3.	 Main menu tab	34
6.2.	Menu functions.....	36
6.2.1.	Measurement.....	36
6.2.2.	Display options	46
6.2.3.	Image gallery	47
6.2.4.	Wizards	50
6.2.5.	Configuration	56
6.2.6.	Audio (only testo 890-2).....	63
6.3.	Measuring	64
7	Maintaining the product	66
8	Tips and assistance	67
8.1.	Questions and answers	67
8.2.	Accessories and spare parts.....	68

2 Safety and the environment

2.1. About this document

Use

- > Please read this documentation through carefully and familiarize yourself with the product before putting it to use. Pay particular attention to the safety instructions and warning advice in order to prevent injuries and damage to the products.
- > Keep this document to hand so that you can refer to it when necessary.
- > Hand this documentation on to any subsequent users of the product.

Warnings

Always pay attention to information that is marked by the following warnings with warning pictograms. Implement the specified precautionary measures.

Representation	Explanation
 CAUTION	indicates potential minor injuries
NOTICE	indicates circumstances that may lead to damage to the products

Symbols and writing standards

Representation	Explanation
i	Note: Basic or further information.
1. ... 2. ...	Action: more steps, the sequence must be followed.
> ...	Action: a step or an optional step.
- ...	Result of an action.
Menu	Elements of the instrument, the instrument displays or the program interface.

[OK]	Control keys of the instrument or buttons of the program interface.
... ...	Functions/paths within a menu.
“...”	Example entries

2.2. Ensure safety

- > Only operate the product properly, for its intended purpose and within the parameters specified in the technical data. Do not use any force.
- > Do not operate the instrument if there are signs of damage at the housing, mains unit or feed lines.

During operation, the imager must not be pointed at the sun or other intensive sources of radiation (e.g. objects with temperatures greater than 550°C/1022°F, if using the high-temperature measurement range 1400°C/2552°F). This can lead to serious damage to the detector. The manufacturer assumes no liability for any such damage to the microbolometer detector.

- > Dangers may also arise from the systems being measured or the measuring environment: Note the safety regulations valid in your area when performing the measurements.
- > Do not store the product together with solvents. Do not use any desiccants.
- > Carry out only the maintenance and repair work on this instrument that is described in the documentation. Follow the prescribed steps exactly. Use only original spare parts from Testo.
- > Improper use of rechargeable batteries can lead to destruction or injuries by means of current surges, fire or escaping chemicals. The following instructions must be observed to avoid such hazards:
 - Only use in accordance with the directions in the instruction manual.
 - Do not short, take apart or modify.
 - Do not expose to heavy impacts, water, fire or temperatures above 60 °C.
 - Do not store in the proximity of metal objects.
 - Do not use leaky or damaged rechargeable batteries. In the event of contact with battery acid: Thoroughly wash affected area with water and consult a doctor, if necessary.
 - Only charge in the instrument or the recommended charging station.

- Immediately stop the charging process if this is not completed in the given time.
- In the event of improper function or signs of overheating, immediately remove the rechargeable battery from the measuring instrument/charging station. Caution: Rechargeable battery may be hot!

2.3. Protecting the environment

- > Dispose of faulty rechargeable batteries/spent batteries in accordance with the valid legal specifications.
- > At the end of its useful life, send the product to the separate collection for electric and electronic devices (observe local regulations) or return the product to Testo for disposal.

3 Specifications

3.1. Use

The testo 890 is a handy and robust thermal imager. It enables you to carry out contactless determination and display of the temperature distribution on surfaces.

Typical areas of application are:

- Building inspection: energetic assessment of buildings, and inspection of heating, ventilation and air conditioning systems.
- Preventative maintenance (servicing): mechanical and electrical inspection of systems, machines and energy distribution systems
- Production monitoring (quality assurance): monitoring of production processes
- Professional energy consultation, leak detection
- Checking of photovoltaic modules

The testo 890 is available in several versions, which are tailored to various usage requirements:

- testo 890-1: high-quality wide angle lens 42° x 32°, detector 640 x 480, NETD < 40 mK at 30°C, 2GB SD card for approx. 800 to 1000 images, SuperResolution with 1280 x 960 pixels (optional), minimum focusing distance 0.1 m, touchscreen, built-in digital imager with power LEDs for illumination, auto-focus, isotherm, min/max/avg on area, image stitching wizard, laser (not available in all countries), rotatable handle, rotatable and pivoting display
- testo 890-2, additional/different functions/features: telephoto lens (optional), super-telephoto lens (optional), display of surface moisture distribution via manual input of the ambient conditions (optional: humidity measurement in real time with radio humidity probe), SiteRecognition (site recognition with image management), voice recording, high temperature measurement (optional), process analysis package - sequence capturing in the camera and video measurement on the PC (optional)

Export control

Thermal imagers may be subject to the export restrictions of the European Union.

Please observe the national regulations for export control when exporting.

3.2. Technical data

Infrared image output

Feature	Values
Detector type	FPA 640 x 480 pixels, a.Si
Thermal sensitivity (NETD)	< 40 mK at 30°C (86°F)
Field of vision/min. focusing distance	42° x 32°/0.1 m (0.33 ft) Telephoto lens (optional): 15° x 11°/0.5 m (1.64 ft) Super-telephoto lens (optional):): 6,6° x 5° / 2 m (6.5 ft)
Geometric resolution (IFOV)	1.13 mrad (standard lens) 0.42 mrad (telephoto lens) 0.18 mrad (super-telephoto lens)
Super-resolution (pixels/IFOV) - optional	1280 x 960 pixels / 0.71 mrad (standard lens) 0.26 mrad (telephoto lens) 0.11 mrad (super-telephoto lens)
Image refresh rate	33 Hz within EU, 9 Hz outside of EU
Focus	Automatic/manual
Spectral range	7.5...14 µm

Visual image output

Feature	Values
Image size	3.1 megapixels
Min. focusing distance	0.5 m (1.64 ft.)

Image presentation

Feature	Values
Image display	LCD touchscreen, 10.9 cm (4.3") screen diagonal, 480 x 272 pixels
Digital zoom	1-3x

Feature	Values
Display options	IR image/real image
Video output	USB 2.0
Video stream	Max. 25 Hz within EU, max. 9 Hz outside EU
Colour palettes	10

Measurement

Feature	Values
Temperature ranges (can be changed)	<p>Measuring range 1, instruments up to serial number 2862504 (see type plate): -20 to 100 °C (-4 to 212 °F)</p> <p>Measuring range 1, instruments from serial number 2862505 (see type plate): -30 to 100 °C (-22 to 212 °F)</p> <p>Measuring range 2: 0 to 350 °C (32 to 662 °F)</p> <ul style="list-style-type: none"> Without high temperature measuring range up to 1200 °C (2192 °F) <p>Measuring range 3: 0 to 650 °C (32 to 1202 °F)</p> <ul style="list-style-type: none"> With high temperature measuring range of 350 to 1200 °C (662 to 2192 °F) <p>Measuring range 3: 350 to 1200 °C (662 to 2192 °F)</p> <p>Measuring range 4: 0 to 650 °C (32 to 1202 °F)</p>

Feature	Values
Accuracy	<p>Measuring range 1 @ -20 to 100 °C (-4 to 212 °F): ± 2 °C (± 3.6 °F)</p> <p>Measuring range 1 @ -30 to -21 °C (-22 to -5 °F), instruments from serial number 2862505 (see type plate): ± 3 °C (± 5.4 °F)</p> <p>Measuring range 2: ± 2 °C (± 3.6 °F) or ± 2 % of m.v. (higher value applies)</p> <ul style="list-style-type: none"> • Without high temperature measuring range up to 1200 °C (2192 °F) Measuring range 3: ± 2 °C (± 3.6 °F) typically 0 to 100 °C (32 to 212 °F) or ± 2 % of m.v. • With high temperature measuring range of 350 to 1200 °C (662 to 2192 °F) Measuring range 3: ± 3 % of m.v. Measuring range 4 ± 2 °C (± 3.6 °F) typically 0 to 100 °C (32 to 212 °F) or ± 2 % of m.v. <p>Information valid for values within the specified measuring range + tolerance</p>
Extended display range	<p>Values with no guarantee of accuracy, prefixed with a tilde (~) on the display. Only for instruments from serial number 2862505 (see type plate):</p> <p>Measuring range 1: -50 to -33 °C (-58 to -27.4 °F)</p> <p>Measuring range 2: -10 to -2 °C (14 to 28.4 °F)</p> <ul style="list-style-type: none"> • Without high temperature measuring range up to 1200 °C (2192 °F) Measuring range 3: -10 to -2 °C (14 to 28.4 °F) • With high temperature measuring range of 350 to 1200 °C (662 to 2192 °F) Measuring range 3: 0 to 343 °C (32 to 649.4 °F) Measuring range 4: -10 to -2 °C (14 to 28.4 °F)
Reproducibility	± 1 °C (± 1.8 °F) or ± 1 % (higher value applies)

Feature	Values
Emissivity/reflected temperature settings	0.01 to 1.00
Reflected temperature/transmission correction (atmosphere) settings	Manual
Minimum measuring point diameter	Standard lens: 3.4 mm at 1 m (3.24 ft.) distance Telephoto lens: 1.3 mm at 1 m (3.24 ft.) distance Super-telephoto lens: 1.1 mm at 2 m (6.5 ft.) distance

Measurement

Feature	Values
Display of surface moisture distribution	Only testo 890-2: via manual input
Humidity measurement with radio humidity probe (not available in all countries)	Only testo 890-2, optional: automatic measurement value transfer in real time
Solar mode	Yes
Analysis functions	Up to 10 measuring points, hot/cold spot detection, area measurement (min/max/average value), isotherm, alarm values, up to 5 range selections

Imager equipment

Feature	Values
Digital imager	Yes
Standard lens	42° x 32°
Telephoto lens	Optional: 15° x 11°
Super-telephoto lens	Optional: 6,6° x 5°
Site recognition with image management	Only testo 890-2

Feature	Values
Image stitching wizard	Yes
Laser (not available in USA, Japan, China)	635 nm, Class 2
Voice recording	Only testo 890-2: via Bluetooth (not available in all countries)/via wired headset
Video measurement (via USB)	Up to 3 measuring points
Full radiometric video measurement (via USB)	Only testo 890-2 (optional)

Image storage

Feature	Values
File format	.bmt, possible export to .bmp, .jpg, .png, .csv, .xls
Video file format (via USB)	.wmv, .mpeg-1 / only testo 890-2: vmt (full radiometric video, testo format)
Storage device	SD card 2 GB (800 to 1000 images)

Power supply

Feature	Values
Battery type	Fast-charging Li-ion battery can be changed on site
Operating time	Approx. 4.5 h at 20 to 30°C (68 to 86°F)
Charging option	In instrument/in charging station (optional)
Mains operation	Yes, with mains unit 0554 8808
Mains unit output voltage	5 V / 4 A

Ambient conditions

Feature	Values
Operating temperature range	-15 to 50°C (5 to 122°F)
Storage temperature range	-30 to 60°C (-22 to 140°F)
Air humidity	20 to 80% non-condensing

Physical features

Feature	Values
Weight	1630 g (including battery)
Dimensions (L x W x H)	253 x 132 x 111 mm (0.83 x 0.44 x 0.37")
Tripod mounting	1/4" - 20 UNC
Housing protection class (IEC 60529)	IP54
Vibration (IEC 60068-2-6)	2G

Bluetooth (not available in all countries)

Feature	Values
Type designation	BlueGiga WT 11
Product note	WT 11
Identification	B01867
Company	10274
Information of the FCC (Federal Communications Commission)	This device fulfils part 15 of the FCC guidelines. Commissioning is subject to the two following conditions: (1) This instrument must not generate any dangerous interference and (2) this instrument must be able to receive interference, even if this could have undesired effects on operation. Changes and modifications to the instrument that have not been expressly approved by testo AG may nullify the user's right to use the instrument.

Feature	Values
Operating information	You can switch off Bluetooth at any time if you wish to save battery power or if the use of radio links is not permitted, e.g. in aircraft or hospitals.

Guidelines, warranty

Feature	Values
EU Directive	2014/30/EC
Warranty	2 years, warranty conditions: see www.testo.com/warranty

4 Product description

4.1. Overview

4.1.1. Product components



- 1 Digital imager lens for taking visual images and two power -LEDs for illuminating the image.
- 2 Infrared imager lens for taking thermograms.
- 3 **[Release lens]** for releasing the lens lock.
- 4 Thread (1/4" - 20 UNC) for attaching a tripod (bottom of imager). Do not use desktop tripods: danger of tipping over!
- 5 Laser (not available in all countries) for marking the measurement object.

i When using the super-telephoto lens the laser for marking the measure object is not available.

CAUTION



Laser radiation! Class 2 laser

> Do not look into the beam.









6 **Focusing ring** for adjusting the focus manually.**CAUTION****Auto mechanism may be damaged!**

> Only turn **focusing ring** when auto-focus is deactivated ().

7 Rotatable handle with adjustable hand strap and fastening loop for the lens cover.

8 Battery compartment (bottom of imager).

9 Operating buttons (back and top of imager):

Button	Functions
	Switch imager on/off
 (5-way joystick)	Press  : open menu, activate selection/setting. Move  up/down/right/left: select functions, navigate
 [Esc]	Cancel action.
 [A],  [B]	Shortcut keys for activating various functions. The current shortcut key assignment is displayed (top left). For adjustable functions, see Configure key, page 60.
 [Trigger button] (round unmarked button)	Press button (only when auto-focus is activated): focus image automatically. Press button: record image (freeze/save).

10 Two fixing eyelets for carrying/shoulder strap.

11 Interface terminals:

Terminal	Assignment
Top	Mains socket, headset socket, Battery status LED. Battery status LED indications (imager on): <ul style="list-style-type: none"> • Off (no battery inserted). • Flashing (mains unit is connected and battery is charging). • On (mains unit is connected and battery is fully charged).
Bottom	USB port, memory card slot.

12 Display, can be flipped out 90° and rotated 270°.

i When the imager is switched on, the display remains active even when folded in. It is advisable to use the power-save options to prolong the battery life, see Power-save options, page 61.

4.1.2. Display interface

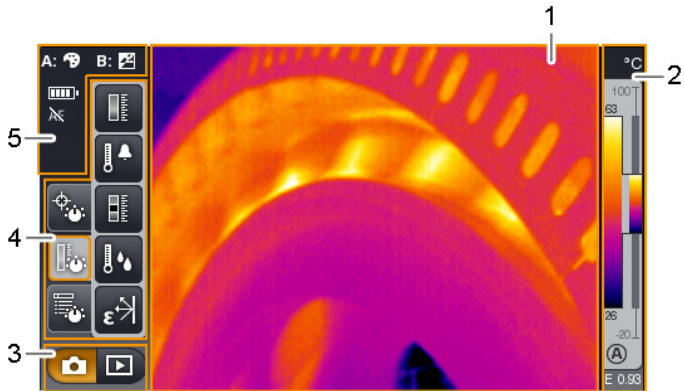

- 1 Image display: shows IR image or real image.
- 2 Scale display:

Display	Description
	Protection glass function activated. No symbol when function is deactivated.
	Selected unit for measurement value and scale displays.
	Left: temperature margin of the image displayed, showing the minimum/maximum measurement value (with automatic scale adjustment) or the selected minimum/maximum display value (with manual scale adjustment). Right: temperature margin of the image displayed, based on the set measurement range, showing the measurement range limits.
	Automatic or manual scale adjustment activated.
	Histogram adjustment activated.

Display	Description
	Set emissivity.

3 Imager mode selection bar:















 button for recording mode,  button for image gallery mode.























4 Menu bar: the menu bar comprises 3 tabs including buttons for selecting functions:



Further information is available under Menu bar/tabs, page **33**.

5 Status displays:

Display	Description
	<p>Possible shortcut key functions (to change the assignment, see Configure key, page 60):</p> <ul style="list-style-type: none"> : Image type. : Emissivity. : Palette. : Scale. : Power -LEDs. : Laser. <div style="border: 1px solid black; padding: 5px; margin: 10px 0;"> <p style="background-color: yellow; margin: 0;">! CAUTION</p> <p style="margin: 0;"> Laser radiation! Class 2 laser > Do not look into the beam.</p> </div> <ul style="list-style-type: none"> : Adjustment. : Zoom in. : Zoom out. : Humidity : Solar : Image stitching

Display	Description
	<p>: Site recognition</p> <p>When viewing a saved image in the single image view of the image gallery, the function buttons are permanently assigned the following functions:</p> <p> A: display previous image.</p> <p> B: display next image.</p>
	<p>Power supply/battery capacity:</p> <p>: Mains operation, battery fully charged.</p> <p>: Mains operation, no battery inserted.</p> <p>: Battery operation, capacity 75-100%</p> <p>: Battery operation, capacity 50-75%</p> <p>: Battery operation, capacity 25-50%</p> <p>: Battery operation, capacity 10-25%</p> <p>: Battery operation, capacity 0-10%.</p> <p> -  -  -  (animated): battery is charging.</p>
 or 	Auto-focus activated or deactivated.
	Only testo 890-2: radio link to radio probe established.
	Only testo 890-2: Bluetooth interface activated.
	Only testo 890-2: headset connected.
	USB connection established.

4.1.3. Operating concept

The imager can be operated in two different ways.

Operation via **touchscreen** offers quick access to functions.

Operation via **joystick** requires more actions but enables single-handed operation of the imager.

Joystick operation

Selection and activation is carried out in two steps: moving the joystick () up/down/right/left moves the orange selection box on the display. The selected function or button is activated by pressing the joystick.

Touchscreen operation

Selection and activation is carried out in one step: the required function or button is selected at the touch of a fingertip and is activated at the same time.



Capacitive touchscreen. Operation is only possible with a bare fingertip (no gloves) or a conductive stylus pen.

Illustration in this document

To carry out the basic settings, examples of both methods of operation are given, describing all steps, see Performing basic settings, page 23.

The other chapters only deal with functions/buttons that have to be activated:

- Touchscreen operation: touch with a fingertip.
- Joystick operation: select first (move joystick up/down/right/left), then activate (press joystick).

4.2. Basic properties

4.2.1. Power supply

The power is supplied to the instrument via a replaceable rechargeable battery or via the mains unit provided.

With an attached mains unit, power is supplied automatically via the mains unit and the instrument's rechargeable battery is charged (only at ambient temperatures from 0 to 40°C).



Under high ambient temperatures a longer charging time may be required.

Charging the battery is also possible using a desktop charging station (accessory: 0554 8851).

The instrument is equipped with a buffer battery to maintain the system data during an interruption in the power supply (e.g. when the battery is changed).

4.2.2. File formats and file names

All saved single images consist of an IR image and attached real image.

The images and videos are saved according to the following pattern: **XXyyyyyy.zzz**

XX:

- **IR** for all single images (standard)
- **ST** for a package consisting of multiple single images (recorded using the panorama image assistant)
- **SQ** sequence in VMT format (recorded using the Sequence Capturing assistant)
- **AA, AB, etc., AZ, BA, BB, etc.:** Single image of a sequence in BMT format (recorded using the sequence capturing assistant).

yyyyyy:

- 6-digit consecutive number.

zzz:

- **bmt** for all images (Testo-specific file extension)
- **vmt** for all videos (Testo-specific file extension).

5 First steps

5.1. Commissioning

5.1.1. Connecting the rechargeable battery

1. Open battery compartment cover (1).
2. Slide rechargeable battery (2) fully into the battery compartment until it clicks into place.

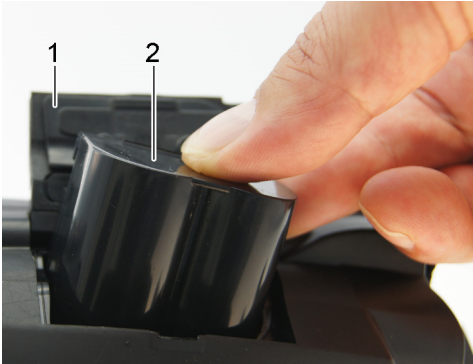



- S
- The imager starts automatically.
3. Close the battery compartment cover.













5.1.2. Performing basic settings

- > Flip open the display and remove the protective film.
- The start screen appears on the display.
- When you first switch on the imager: the **Country settings** and **Set time/date** dialogue boxes are opened one after the other to set the instrument language, temperature unit (°C/°F) and time/date.













Touchscreen operation





- ✓ The **Country settings** dialogue box is opened.

1. Touch the required language. If necessary, scroll with  /  to display other languages.
 - The activated language is indicated with a tick.

2. Touch  to change the unit.
 - The activated unit is shown on the top right of the display.
 3. Touch  to confirm the entry.
 - The **Set time/date** dialogue box is opened.
 4. Touch the top button  to open the **Time** input screen.
 5. Set values for **Hour** and **Minute** with  / .
 6. Touch  to confirm the entry.
 7. Touch the bottom button  to open the **Date** input screen.
 8. Set values for **Day**, **Month** and **Year** with  / .
 9. Touch  to confirm the entry.
 10. Touch  to close the input screen.
- > Hold down  to close the imager.

Joystick operation

- ✓ The **Country settings** dialogue box is opened.
1. Move  up/down to select the required language.
 - An orange box appears around the selected language.
 2. Press  to activate the selection.
 - The activated language is indicated with a tick.
 3. Move  left/up to select .
 4. Press  to change the unit.
 - The activated unit is shown on the top right of the display.
 5. Move  down to select .
 6. Press  to activate the selection.
 - The **Set time/date** dialogue box is opened.
 - The top button  is selected.
 7. Press  to open the **Time** input screen.
 8. Move  up/down to set the values for **Hour** and **Minute**. To toggle between the parameters, move  left/right.

9. Move [•] left to select .
 10. Press [•] to activate the selection and close the input screen.
 11. Move [•] down to select the bottom button .
 12. Press [•] to open the **Date** input screen.
 13. Move [•] up/down to set the values for **Day**, **Month** and **Year**.
To toggle between the parameters, move [•] left/right.
 14. Move [•] left to select .
 15. Press [•] to activate the selection and close the input screen.
 16. Move [•] left to select .
 17. Press [•] to activate the selection and close the input screen.
- > Hold down  to close the imager.

5.1.3. Initial charging of the rechargeable battery

The imager is delivered with a partially charged battery. Fully charge the battery before use.

- > Connect the country-specific adapter required for the existing mains to the mains unit.

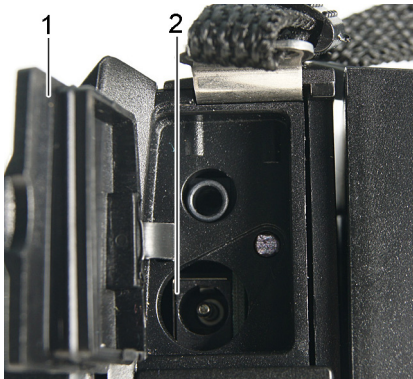

1. Open the cover of the top interface terminal (1).
2. Connect the mains unit to the mains socket (2).

3. Connect the mains plug to a power socket.
 - The imager starts automatically.

i The rechargeable battery can be recharged with the imager switched on or off. This has no effect on the time required to charge the battery.

- Charging of the battery is started.
- The charge status is indicated by the status LED (3):
 - LED flashes: charging in process.
 - LED lights: battery charged, charging process finished.
- 4. Fully charge the battery, then disconnect the instrument from the mains unit.
 - After initial charging of the battery, the imager is ready for use. A desktop charging station (accessory: 0554 8851) can also be used to charge the battery.

5.2. Getting to know the product

5.2.1. Adjusting the hand strap



- > Lay the imager on its left side.
 1. Open out the top of the hand strap padding (1).
 2. Pull the fastening end of the strap up (2).
 3. Put your right hand through the hand strap from the right-hand side.
 4. Adjust the hand strap by loosening/tightening it to fit your hand and secure the fastening end again.
 5. Fold down the top of the hand strap padding.

5.2.2. Attaching the lens cover to the hand strap



- > Guide the clip on the lens cover (1) through the loop on the handle (2).

5.2.3. Rotating the handle

The handle can be rotated up to 180° in 10 positions.



1. Put your right hand through the hand strap.
2. Grip the imager with your left hand. To do this, hold the casing at the front of the imager (1).

CAUTION

Display may be damaged!

> Do not hold the imager by the fold-out display.

3. Turn your right hand to move the handle to the required position (2). Press down with your middle and ring finger. To rotate in the opposite direction, press up with the heel of your hand.

5.2.4. Attaching a shoulder strap



- > Link together shoulder strap click locks and the carrying strap attached to the imager.

5.2.5. Using a lens case

The lens case (included in the scope of delivery of the interchangeable lens) is used to protect and transport the interchangeable lens. It can be attached using the carabiner e.g. to a belt loop.

To protect against damage to lenses not being used, the transparent plastic cap must always be attached to the back of the lens. Make sure that the case zip is properly zipped up.

5.2.6. Inserting the memory card

1. Open the cover of the bottom interface terminal (1).
2. Push the memory card (SD or SDHC card) into the card slot (2).

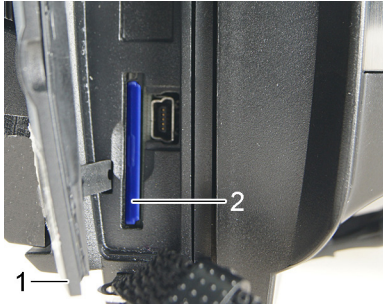

- > To remove the memory card: press the memory card to release the lock.

5.2.7. Fitting/removing IR protection glass

- i** It is not possible to use IR protection glass in conjunction with a super-telephoto lens.

The lens focusing ring has an internal thread for fitting the protection glass.

Fitting

- > Insert the protection glass into the lens focusing ring and turn clockwise as far as it will go.

Removing

- > Turn the protection glass anti-clockwise and remove it.
- After fitting or removing the protection glass, activate or deactivate the **Protection glass** option, see Optics, page 60. If this option is set incorrectly, the specified measuring accuracy is not guaranteed.

5.2.8. Changing the lens

Only lenses that have been adjusted to the respective thermal imager can be used. The serial number on the lens must match the serial number displayed in the imager, see Optics, page 60.

> Place the imager on a stable base.

Removing the lens





1. Grip the lens with your left hand (1), hold the imager with your right (2) and press **[Release lens]** (3).
2. Unscrew lens by turning it anti-clockwise and remove.

Always keep lenses in the lens case (included in the scope of delivery of the interchangeable lens) while they are not in use.

Attaching a new lens

1. Grip the lens with your left hand (1) and hold the imager with your right (2).
2. Line up the marks on the lens and the instrument (4) and place the lens in the lens mount.
3. Push the lens into the mount as far as it will go and turn it clockwise until it clicks into place.

5.2.9. Switching the imager on/off

1. Remove protection cap from the lens.
2. Press .
 - The start screen appears on the display. Instrument information is displayed (e.g. serial number, type designation, firmware version).
 - The measurement view is opened. Measurement values on the cursor and scale are only displayed when the stabilisation phase is complete (indicated by a rotating symbol in the top right of the display).
 - The imager performs automatic adjustment approx. every 60 s. This can be recognized by means of a "click". The image is frozen briefly when this occurs.
- > To switch off: Hold down  until the confirmation prompt is no longer displayed.
 - The imager is switched off.

5.2.10. Manually focusing the image

CAUTION

Auto mechanism may be damaged!

- > Only turn **focusing ring** when auto-focus is deactivated ().





- > Deactivate auto-focus:  | .
-  is displayed.
- > Turn the lens **focusing ring** until the image is in sharp focus.



For focusing, observe the appropriate minimum distance depending on the lens used:

- telephoto lens 0.5 m (1.64 ft)
- super-telephoto lens 2 m (6.5 ft)

5.2.11. Automatically focusing the image

- > Activate auto-focus:  | .
-  is displayed and  is highlighted orange.
- > Touch **[Trigger button]**.
- The image is automatically focussed. The area to be focussed must be inside the orange box, which is shown by touching the trigger button.

5.2.12. Recording (freezing/saving) an image

1. Press the **[Trigger button]**.
- The image is frozen (still).

If you want to save the image, touch  to select where you want to save it to, see Image gallery, page 47.

2. Save image: press **[Trigger button]** again or touch .
- The IR image is saved and the real image is automatically attached to the IR image.
- > Do not save image: press **[Esc]**.





6 Using the product

6.1. Menu bar/tabs

Functions are called up via the menu bar. The menu bar comprises 3 tabs. Different functions are available depending on which tab is selected.





Tabs and functions are described briefly below. Detailed information about the individual functions is given in the following chapters.

6.1.1. Analysis functions tab

Button	Function	Description
	New mark	Insert new measuring point mark. See also Pixel mark New mark, page 37.
	Min/Max on Area	Show area mark. See also Min/max/avg on area, page 38.
	Hotspot	Display maximum measurement value. When the function is enabled, the button is highlighted orange. See also Pixel mark Hotspot, page 37.
	Coldspot	Display minimum measurement value. When the function is enabled, the button is highlighted orange. See also Pixel mark Coldspot, page 37.
	Image type	Change display: toggle between IR image and real image.

6.1.2. Scale and correction functions tab





Button	Function	Description
	Scale	Open Scale manual input screen. To adjust the measurement value scale. See also Scale manual, page 45.

Button	Function	Description
	Alarm	Open Alarm input screen. To set the limits and activate/deactivate the function. See also Alarm, page 40 .
	Isotherm	Open Isotherm input screen. To set the limits and activate/deactivate the function. See also Isotherm, page 40 .
	Humidity	Only testo 890-2: Open Humidity input screen. To set the parameters and activate/deactivate the function See also Humidity (only testo 890-2) , page 41 .
	Emissivity	Open Emissivity input screen. To set the parameters. See also Emissivity, page 43 .

6.1.3. Main menu tab











The displayed functions on the tab differ depending on the current view.

View of current image

Button	Function	Description
	Menu	Open menu. Via the menu, most functions from the 3 tabs and many additional functions can be called up. See Measurement, page 36 .
	Auto-focus	Activate/deactivate auto-focus.
	Zoom in	To zoom in on the image (digital zoom, 5 increments).
	Zoom out	To zoom out of the image to the full image view.

Button	Function	Description
	Site recognition	Only testo 890-2: To record site markers. The button is not displayed as default. It has to be re-activated every time the imager is switched on: call up the SiteRecognition function again from the menu and set a marker.

Frozen or saved image view

Button	Function	Description
	Menu	See above.
	Save	Save image. Function only available when the image is frozen.
	Folder	Open Folder input screen. To select where to save images. Function only available when the image is frozen.
	Audio	Only testo 890-2 when connected to a headset: open Audio input screen, see see Audio (only testo 890-2), page 63 .
	Sub-level zoom	Sub-level zoom with additional functions is displayed.  : menu, see above.  : zoom in, see above.  : zoom out, see above.  : display buttons for moving the zoomed image. To move, touch the buttons shown in the image.  : close sub-level zoom.

Button	Function	Description
	Delete image	Function only available when the image is saved.

6.2. Menu functions

6.2.1. Measurement

Measurement range









The measurement range can be set to adapt to the respective area of application. If measurement range 3 is selected (high-temperature measurement range), the aperture in the lens is automatically reduced to protect the detector against damage.

i When using a super-telephoto lens, it is not possible to select the measuring range up to 1200 °C (2192 °F).

CAUTION





Detector may be damaged!

- > If measurement range 1 and 2 are set: do not point the camera at objects with temperatures exceeding 550 °C (1022 °F).
- > If measuring range up to 650 °C (1202 °F) is set: do not point the camera at objects with temperatures exceeding 650 °C (1202 °F).
- > If measuring range up to 1200 °C (2192 °F) is set: do not point the camera at objects with temperatures exceeding 1400 °C (2552 °F).

Task	Actions/description
Set the measurement range.	>   Measurement  or  Measurement range  or  or  or 
Disable/enable warning message when saving images with readings outside the measuring range.	>  Over-/Underrange Warning. > To disable, touch the button again





Pixel mark | Hotspot

Hotspot mark (crosshairs with maximum measurement value displayed) can be shown.

Task	Actions/description
Show/hide hotspot mark.	>   . or >   Measurement Pixel mark Hotspot.





Pixel mark | Coldspot

The coldspot mark (crosshairs with minimum measurement value displayed) can be shown.

Task	Actions/description
Show/hide coldspot mark.	>   . or >   Measurement Pixel mark Coldspot.

Pixel mark | New mark







Up to 10 measuring point selections (crosshairs with reading display) can be shown and freely positioned.





Task	Actions/description
Insert new mark.	>   . or >   Measurement Pixel mark New mark.

Task	Actions/description
Move crosshairs.	> Touch and drag crosshairs. Joystick operation: <ol style="list-style-type: none"> 1. Select crosshairs and activate by pressing the joystick. 2. Move crosshairs by moving the joystick. > To exit: Press joystick again and activate Quit moving in the context menu.
Hide crosshairs.	> Double-touch the crosshairs and touch Hide in the context menu. Joystick operation: <ol style="list-style-type: none"> 1. Select crosshairs and press joystick twice. 2. In the context menu, activate Hide.

Min/max/avg on area









A range selection can be shown and freely positioned. It is possible to display up to 5 marks for minimum (**min**), maximum (**max**) and average (**avg**) readings in this area.

Task	Actions/description
Show area mark.	>  
Show more range selections	>   or >   Measurement Pixel mark New Min/Max on Area

Task	Actions/description
Move area mark.	<p>> Touch and drag area mark.</p> <p>Joystick operation:</p> <ol style="list-style-type: none"> 1. Select area mark and activate by pressing the joystick. 2. Move area mark by moving the joystick. <p>> To exit: Press joystick again and activate Quit moving in the context menu.</p> <p>i All marks displayed within the range selection are moved.</p>
Change size of area mark/hide area mark.	<p>> Tap range selection.</p> <p>Enlarge range selection</p> <p>> Press .</p> <p>Shrink range selection</p> <p>> Press  again..</p>
Hide range selection	<p>> Tap range selection.</p> <p>> Press .</p>
Hot spot display in the range selection	<p>> Tap range selection.</p> <p>> Press .</p>
Cold spot display in the range selection	<p>> Tap range selection.</p> <p>> Press .</p>









Alarm

The alarm function shows all image points with measurement values that exceed the upper alarm mark or fall below the lower alarm mark in a single colour (alarm colour). To set the alarm colours, see Colour selection, page 47.

Task	Actions/description
Open Alarm input screen.	>   . or >   Measurement Alarm .
Activate/deactivate Lower alarm or Upper alarm .	>  Active . > To deactivate, touch the button again.
Set alarm values.	>  ,  .
Apply entries.	>  .

Isotherm

The isotherm function shows all image points with measurement values that lie within the set limits in a single colour (isotherm colour). To set the isotherm colour, see Colour selection, page 47.









Task	Actions/description
Open Isotherm input screen.	>   . or >   Measurement Isotherm .
Activate/deactivate isotherm display.	>  Active . > To deactivate, touch the button again.
Set lower and upper isotherm limit.	>  ,  .
Link setting for upper/lower limits.	>  .

Task	Actions/description
Apply entries.	>  .

Humidity (only testo 890-2)

The ambient temperature and humidity values entered manually or measured by the optional radio humidity probe are used to calculate the relative surface moisture for each pixel. The values can be shown as a humidity image. The special colour palette indicates which areas are at risk of mould:







Colour	Surface moisture	Assessment
green	0...64%RH	non-critical
yellow/orange	65 to 80%RH	potentially critical
red	>80%RH	critical

Task	Actions/description
Open Humidity input screen.	>   or >   Measurement Humidity .
Activate/deactivate humidity image display.	>  Active . > To deactivate, touch the button again.
Set values manually for ambient temperature (Ambient temp.) and ambient humidity (Humidity):	>  ,  .
Set up radio link to the optional radio humidity probe.	>  Further information is available under Radio (only testo 890-2), page 58.
Apply entries.	>  .

Atmospheric correction

Measurement deviations arising due to high humidity or large distances to the object to be measured can be corrected. Correction parameters must be entered for this.

If the imager is connected to an optional radio humidity probe (only testo 890-2), the ambient temperature and humidity are transferred automatically. For connection to a radio humidity probe, Further information is available under Radio (only testo 890-2), page 58..





Task	Actions/description
Open Atmospheric correction input screen.	>   Measurement Atmospheric correction.
Activate atmospheric correction.	>  Active. > To deactivate, touch the button again.
Manually set the values for the ambient temperature (Temperature), ambient humidity (Humidity) and distance between the imager and the object to be measured (Distance to subject).	>  ,  .
Apply entries.	>  .

Solar

To detect and document failures in photovoltaic systems, the solar function can be selected. The sun's radiation intensity measured (with an external instrument) can be entered for documentation purposes. This value is saved with the IR- image.

If this function is activated, the entered value for the radiation intensity is displayed (top left).

Task	Actions/description
Open Solar input screen.	>   Measurement Solar.

Task	Actions/description
Activate solar functions.	<ul style="list-style-type: none"> >  Active. > To deactivate, touch the button again.
Manually set the value for radiation intensity (Temperature).	<ul style="list-style-type: none"> >  , .
Apply entries.	<ul style="list-style-type: none"> > .

Emissivity

You can choose between user-defined emissivity and 8 materials with set emissivity. The reflected temperature (RTC) can be set individually.

Emissivity information:

The emissivity describes the capability of a body to emit electromagnetic radiation. This is material-specific and must be adapted for correct measurement results.

Non-metals (paper, ceramic, gypsum, wood, paints and coatings), plastics and food have high emissivity, which means that the surface temperature can be easily measured using infrared.

Because of their low or non-uniform emissivity, bright metals and metal oxides only have limited suitability for infrared measurement. Highly inaccurate measurements should be expected. A remedy for this is coatings that increase emissivity, e.g. paint or emission adhesive (accessory, 0554 0051), which must be applied to the object to be measured.

The following table gives typical emissivities of important materials. These values can be used as a guide for user-defined settings.

Material (material temperature)	Emissivity
Aluminium, bright rolled (170°C)	0.04
Cotton (20°C)	0.77
Concrete (25°C)	0.93
Ice, smooth (0°C)	0.97
Iron, emery ground (20°C)	0.24
Iron with casting skin (20°C)	0.80
Iron with rolling skin (20°C)	0.77
Gypsum (20°C)	0.90







Material (material temperature)	Emissivity
Glass (90°C)	0.94
Rubber, hard (23°C)	0.94
Rubber, soft grey (23°C)	0.89
Wood (70°C)	0.94
Cork (20°C)	0.70
Radiator, black anodised (50°C)	0.98
Copper, slightly tarnished (20°C)	0.04
Copper, oxidized (130°C)	0.76
Plastics: PE, PP, PVC (20°C)	0.94
Brass, oxidized (200°C)	0.61
Paper (20°C)	0.97
Porcelain (20°C)	0.92
Black paint, matt (80°C)	0.97
Steel, heat-treated surface (200°C)	0.52
Steel, oxidized (200°C)	0.79
Clay, burnt (70°C)	0.91
Transformer paint (70°C)	0.94
Brick, mortar, plaster (20°C)	0.93

Reflected temperature information:

Using this offset factor, the reflection is calculated out based on the low emissivity, and the accuracy of the temperature measurement with infrared instruments is improved. In most cases, the reflected temperature is identical to the ambient air temperature. Only when objects with strong emissions and much higher temperatures (such as ovens or machines) are in proximity to the object being measured should the radiation temperature of these heat sources be determined and used (e.g. using a globe thermometer). The reflected temperature has little effect on objects with high emissivity.













Using the PC software, other materials can be imported into the instrument from an existing list.

Task	Actions/description
Open Emissivity input screen.	>   . or >   Measurement Emissivity .
Select material.	> Highlight the material to be used by touching on it.
Manually set the emissivity (only when User defined is selected) and reflected temperature (RTC).	>  ,  .
Apply entries.	>  .

Scale manual

Manual scaling can be activated instead of automatic scaling (continuous automatic adjustment to the current min./max. values). The scale limits can be set within the activated measurement range (see Measurement range, page 36).

The activated mode is displayed bottom right:  manual scaling,  automatic scaling.



Task	Actions/description
Open Scale manual input screen.	>   . or >   Measurement Scale manual .
Activate/deactivate manual scale adjustment.	>  Active . > To deactivate, touch the button again.
Set scale limits.	>  ,  .
Link setting for upper/lower limits.	>  .

Task	Actions/description
Apply entries.	> 

6.2.2. Display options

Palette

You can choose from 10 existing colour palettes for the IR image display.

Task	Actions/description
Open Palette input screen.	>   Display options Palette.
Select palette.	> Highlight the palette to be used by touching it.
Apply entries.	> 

Histogram adjustment





By adjusting the colour palette to the current temperature distribution, histogram adjustment particularly in the case of scenes with a large temperature scope (e.g. with high-temperature measurements) increases the contrast.

i When histogram adjustment is activated, the colours within the scale are no longer distributed in a linear pattern between the minimum and maximum scale value. It is therefore difficult to draw conclusions about temperatures from colours.

Task	Actions/description
Activate/deactivate Histogram adjustment.	>   Display options Histogram adjustment.

Colour selection

The colours used for the measurement functions **Isotherm** and **Alarm** can be set.

Task	Actions/description
Open Colour selection input screen.	>   Display options Colour selection.
Set required colour for Isotherm , Top Alarm or Bottom Alarm .	>  . > Activate colour to be used by touching it.
Apply entries.	>  .

6.2.3. Image gallery

The saved image can be viewed and analysed in the image gallery. Folders can be created for saving new images to.





Only testo 890-2: it is possible to listen to and also subsequently record or edit a voice commentary. Images with a voice commentary are indicated with the following symbol: .

Task	Actions/description
Open image gallery.	>  . or >   Image gallery.
Close image gallery.	>  .

Navigation on the overview page



Task	Actions/description
Open folder.	> Double-touch the symbol for the folder to be opened.
One level up.	>  .
Open single image view.	> Double-touch the preview image to be opened. For further information on the single image view, see below.

Actions on the overview page

Task	Actions/description
Create a new folder.	>  > Enter folder name. >  .
Delete folder or image.	1. Select folder or image by touching on it.  2.  3. Confirm deletion:  .









Navigation in the single image view

✓ The single image view must be opened: see above.

Task	Actions/description
Open main menu to activate functions.	>  .
Display next or previous image.	> [A] or [B] .
Back to overview page:	>   Image gallery .
Close image gallery:	> [Esc] .

Actions in the single image view

✓ The single image view must be opened: see above.

Task	Actions/description
Open main menu to activate functions.	> 
Delete image.	>  > Confirm deletion: 
Record/edit voice commentary (only testo 890-2).	>  Further Information: See Audio (only testo 890-2), page 63 ..
Open sub-level zoom with additional functions.	>  : menu, see above. >  : to zoom in on the image (digital zoom, 5 increments). >  : to zoom out of the image to the full image view. >  : display buttons for moving the zoomed image. To move, touch the buttons shown in the image. >  : close sub-level zoom.

6.2.4. Wizards

Sequence Capturing (optional, only testo 890-2)

A sequence of images can be recorded using the Sequence Capturing assistant.

i This function is available as an additional option (article no. 0554 8902) and must be activated before it can be used, if the option was not ordered at the same time as the imager.

Activate function (only with subsequent order):

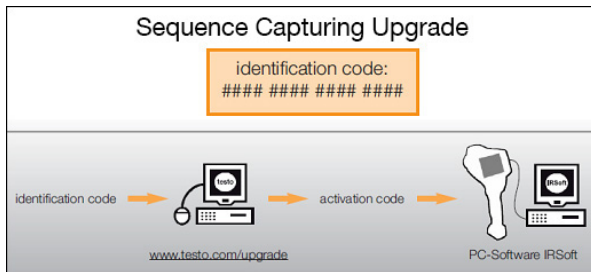

you will receive an envelope with an access code (identification code), which you should enter on the website www.testo.com/upgrade.



When all necessary data has been entered, an activation code is generated and can be used to activate the function via the IRSoft PC software. Please observe the installation requirements and steps on the website or in the email sent to you.

i The sequences can be saved in various formats:

- BMT files:
sequence of individual image files (thermal images), saved in a folder, folder name starts with **SQ**. Image marks placed prior to recording (measuring points and profile lines) are also saved as image data and cannot be subsequently changed or deleted.
The individual thermal images of the sequence can be displayed and analysed.
 - VMT files (full radiometric video): video file in which image data, measuring values and image marks are saved, file name starts with **SQ**.
Saved files can be played back in testo IRSoft and subsequently analysed over time by adding or changing image marks.
-

The playback speed (frames per second) corresponds to the video frequency of the camera, if the system environment supports this frequency (see system requirements), but max. 25 Hz.

If the **Humidity** and / or **SuperResolution** functions are enabled, when the sequence assistant is called up they are disabled. These functions are enabled once again when you exit the Sequence Capturing assistant.

Task	Actions/description
Call up function	  Assistants Sequence Capturing.
Set recording parameters	<p>A sequence is configured using the following parameters:</p> <ul style="list-style-type: none"> • Format: VMT (video file) or BMT without / with Real image (images are saved in a container folder and can be edited individually). • Start: Manual (when the shutter button is pressed), Countdown (automatic start after expiration of the set time), Max. temperature > (automatic start following upper temperature deviation in the overall image), Min. temperature < (automatic start following lower temperature deviation in the overall image), Range: Max. temperature > (automatic start following upper temperature deviation within the range selection), Range: Min. temperature < (automatic start following lower temperature deviation within the range selection). <hr/> <p>i Sequence capturing relates only to the range selection first created. This is displayed in red. Other range selections are displayed in orange.</p> <hr/> <ul style="list-style-type: none"> • Interval: Time (time between the taking of two images), Manual (when the shutter button is pressed). • End: Number of images. <ol style="list-style-type: none"> 1. Touch parameter. <ul style="list-style-type: none"> - The input screen opens.







Task	Actions/description
	2. Select criterion / adjust values. 3.  .
Enable / disable shutter	In the case of stable environmental conditions and set-ups that do not heat up the sensor / camera, the automatic shutter function can be disabled. This can prevent individual images of the sequence being recorded with a time delay (outside the programmed capturing interval). Deviations in accuracy and image quality when the shutter is disabled are negligible in a period of up to 60 minutes. >  . - Icon is highlighted orange: shutter is enabled. - Icon is not highlighted orange: shutter is disabled.
Select where to save image	>  . - The Folder input screen opens.
Activate sequence	>  . - A white, flashing dot (top right of the display) indicates standby status until the start of recording. When the Countdown start criterion is selected, the remaining time until the start is also displayed. - The recording proceeds from the start criterion entered. A red, flashing dot (top right of the display) indicates that the recording is ongoing. The number of images recorded is displayed to the left of it. The file name is displayed at the top left of the display.
Show / hide configuration settings	Function is only available when a sequence is activated. >  (hide) or  (show).
Deactivate sequence / end recording	>  .

Image stitching

The image stitching wizard can be used to produce a large panoramic image from up to 3x 3 single images. The wizard helps when recording the single images and ensures that there is sufficient overlap for stitching together to create a panoramic image using the PC software.

Before calling up the function, please note:

When the function is called up, the scale is set to manual and the temperature scope at this time is fixed. This temperature scope may not be sufficient for the entire panoramic image.

Recommendation:

- > Scan the entire object for the panoramic image to determine the required temperature scope (minimum/maximum measurement value). Set scale to manual and set scale limits, see Scale manual, page 45.



If the **SuperResolution** function is activated, it is deactivated when the image stitching wizard is called up. When the image stitching wizard is ended, SuperResolution is activated again.





When recording single images, please note:



When capturing single images, please note:

- > Rotate the camera with your wrist. Do not move it horizontally. Ideally, use a tripod.





Task	Actions/description
Call up function.	>   Wizards Image stitching.
Record single images.	<ol style="list-style-type: none"> 1. Record single image 1 (top left): [Trigger button]. 2. Rotate the camera to the right until the image is cleanly joined to the semi-transparent image strip of individual image 1. 3. Record single image 2 (top centre): [Trigger button].

Task	Actions/description
	<p>4. Carry out the steps accordingly for the other single images.</p> <p>Depending on the single images already recorded, fixed parts of the image are shown in the left or top half of the image. The current image must be joined accordingly to the image on the left or above.</p> <hr/> <p>i When carrying out alignment to determine where the next single image must be joined, the single image overview helps, see below.</p> <hr/> <p>To record the single images in another order, see single image overview (below).</p>
<p>Display single image overview and select single image to delete/replace it.</p>	<p>1. .</p> <ul style="list-style-type: none"> - The single image overview is displayed. <p>For a realistic display of the panoramic image, a projection on a semi-circular surface is required. As the image is displayed on one plane, it is distorted around the edges.</p> <p>2. Select single image: Touch single image. Images not available for selection are indicated with a "X".</p> <ul style="list-style-type: none"> > Delete selected single image: . > Replace selected single image: Close single image overview and record single image again. > Close single image overview: .
<p>Save panoramic image.</p>	<ul style="list-style-type: none"> > .
<p>Select where to save image.</p>	<ul style="list-style-type: none"> > .

Task	Actions/description
	- The Folder input screen is opened.
Close image stitching wizard.	<ol style="list-style-type: none">  . Acknowledge confirmation prompt.

SiteRecognition (only testo 890-2)





With the PC software, markers can be set to clearly indicate a measuring site. By setting a marker with the built-in digital imager, the images, which are then saved, are automatically allocated to the relevant site (allocation is saved with this image). For the creation of markers, transferring of measuring site data to the imager and copying of images to the PC software, see instruction manual for the PC software.

Task	Actions/description
Call up function.	<p>>   Wizards SiteRecognition.</p> <p>- The real image is displayed and a position frame is shown.</p> <p>Once the function has been called up via the menu (see above) and at least one marker has been set, the function can also be called up via the main menu tab.</p> <p>>  .</p> <p>When the imager is switched off, the entry is removed again from the tab.</p>
Enter measuring site marker.	<ol style="list-style-type: none"> Position the imager so that the marker is inside the position frame. After recognition of the marker ID: confirm transfer of measuring site data.

6.2.5. Configuration

Country settings

Instrument language and temperature unit can be set.

Task	Actions/description
Open Country settings input screen.	>   Configuration Country settings .
Set the language of the program interface.	> Highlight the language to be used by touching on it.
Change temperature unit.	>  - The activated unit is shown on the top right of the display.
Apply entries.	>  .

Super-resolution (optional)

SuperResolution is a technology to improve image quality. Each time an image is recorded, a sequence of images is saved on the thermal imager and used to calculate a higher-resolution image with the aid of the PC software (no interpolation). The pixel count increases by a factor of 4, while the geometric resolution (IFOV) is improved by a factor of 1.6.

To use the function, the imager must be hand-held (no tripod).



This function is available as an additional option (article no. 0554 7806) and must be activated before it can be used, if the option was not ordered at the same time as the imager.

Activate function (only with subsequent order):

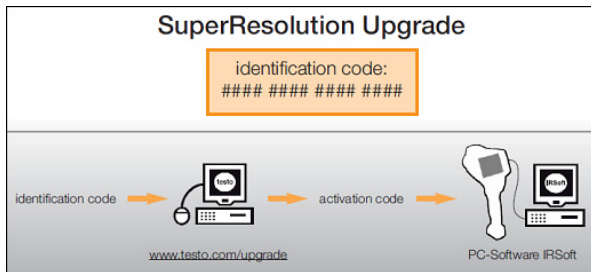



You will receive an envelope with an access code (identification code), which you should enter on the website www.testo.com/upgrade.

When all necessary data has been entered, an activation code is generated and can be used to activate the function via the IRSoft PC software. Please observe the installation requirements and steps on the website or in the email sent to you.



To use the function, the following conditions must be fulfilled:



- The imager is hand-held (no tripod).
- The objects to be imaged do not move.

Task	Actions/description
Activate/deactivate function.	<p data-bbox="538 544 960 632">>   Configuration SuperResolution.</p> <hr/> <p data-bbox="538 647 960 762">i If the function is activated, when an image is frozen, (SR) is displayed additionally behind the Save Image? box.</p>

Save JPEG

Infrared images are saved in BMT (image with all temperature data) format. The image can also be saved in JPEG format (without temperature data) at the same time. The image content corresponds to the infrared image shown on the display, including scale display and image marks for the selected measuring functions. Date and time the photo was taken can be displayed in the image. The JPEG file is saved under the same file name as the associated BMT file and can be opened on the PC, even without using the IRSoft PC software.





Task	Actions/description
Disable/enable Save JPEG function.	<p data-bbox="538 1158 965 1222">1.   Configuration JPEG.</p> <p data-bbox="538 1222 965 1286">2. Select Save JPEG function by touching (☑).</p> <p data-bbox="538 1286 965 1324">> To disable, repeat these steps.</p>

Task	Actions/description
Disable/enable Show date/time function (Save JPEG function must be enabled).	  Configuration JPEG . 1. 2. Select Show date/time function by touching (<input checked="" type="checkbox"/>). > To disable, repeat these steps.

Bluetooth (only testo 890-2)

This function is not available in all countries.

Via the Bluetooth radio interface, a link to a Bluetooth headset can be established for voice recording. Follow the instruction manual for the Bluetooth headset.

Task	Actions/description
Open Bluetooth input screen.	>   Configuration Bluetooth .
De-/activate Bluetooth radio link.	>  Active . > To deactivate, touch the button again.
Search for Bluetooth devices and establish link.	1.  . - A search is carried out for Bluetooth devices (with enabled pairing mode) and available devices are displayed. 2. Establish link to Bluetooth device: select device by touching it (<input checked="" type="checkbox"/>).
Apply entries.	>  .

Radio (only testo 890-2)

This function is not available in all countries.







A radio humidity probe can be logged onto the instrument.

Every radio probe has a probe identification number (RFID). This is made up of the three-digit RFID number on the probe and the position of the switch in the battery compartment of the radio probe (**H** or **L**). To be logged on at the instrument, the radio probe must be switched on and the transfer rate must be set to 0.5 s. This is

done by briefly pressing the on/off button when switching on (also see instructions for use of radio probe).



If no radio probe is found, this may be because of the following:

- The radio probe is not switched on or the radio probe battery is dead.
 - The radio probe is outside the radio range.
 - Sources of interference influence radio transmission (e.g. reinforced concrete, metal objects, walls or other barriers between the transmitter and receiver, other transmitters of the same frequency and strong electromagnetic fields).
- > If necessary: Rectify the possible causes of the fault in radio transmission.

Task	Actions/description
Open Radio input screen.	>   Configuration Radio .
Activate/deactivate radio and establish connection to a radio humidity probe.	1.  Active . - A search is carried out for radio probes and available radio probes are displayed. 2. Highlight the radio probe to be used by touching it (). > To deactivate, touch the button  again.
Apply entries.	>  .

Configure key

The assignment of the shortcut keys can be changed.

Task	Actions/description
Open Configure key input screen.	>   Configuration Configure key .
Activate button function.	> Highlight the function to be used by touching on it. The following functions can only be activated via the shortcut keys: <ul style="list-style-type: none"> • Light: switch on/off power LEDs for lighting up objects for the digital imager. • Laser: switch on laser marker for marking the measuring surface. Operating information: the shortcut button must be held down to activate the laser. When the laser is activated, an extra cursor is displayed. This marks the precise point at which the laser appears on the object. • Adjustment: Carry out adjustment.
Apply entries.	>  .

Optics





The lenses adjusted to the instrument are shown. Only the lenses that are shown may be used. Lens activation is automatic (not in USA).

The **Protection glass** option can be used to set whether protection glass is fitted. Ensure the correct setting to prevent corruption of the measurement results.















It is not possible to use IR protection glass in conjunction with a super-telephoto lens.

Task	Actions/description
Open Optics input screen.	>   Configuration Optics .

Task	Actions/description
Manually activate fitted lens (only required in USA).	> Highlight the lens to be used by touching on it.
Activate/deactivate protection glass option.	<ul style="list-style-type: none"> >  Protection glass. > To deactivate, touch the button again. - When the option is activated, the protection glass symbol () is displayed top right. > To deactivate, touch the button .
Apply entries.	>  .







Power-save options

The options affecting battery life can be set.

Task	Actions/description
Open Power-save options input screen.	>   Configuration Power-save options.
Set the brightness of the LCD backlight:	<ul style="list-style-type: none"> >  (low) or  (medium) or  (high).
Activate/deactivate automatic switch-off function LCD off or Imager off and set the switch-off time.	<ul style="list-style-type: none"> 1.  Active. 2.   ,  . > To deactivate, touch the button .
Apply entries.	>  .

Set time/date



Time and date can be set. The time and date format are set automatically based on the selected instrument language.

Task	Actions/description
Open Set time/date input screen.	>   Configuration Set time/date .
Set time or date values.	>  >   >  .
Apply entries.	>  .

Reset counter



Please note: After a reset, the consecutive numbering of images starts again from the beginning. When saving images in the same folder, already saved images with the same number are overwritten!

> Back up all saved images before performing a reset to prevent possible overwriting.

Task	Actions/description
Execute function.	1.   Configuration Reset counter . 2. Confirm reset:  .

Delete all



The data on the memory card can be deleted.

Task	Actions/description
Execute function.	1.   Configuration Delete all . 2. Confirm deletion:  .

Format

The memory card can be formatted.



Please note: During formatting, all saved data on the inserted memory card is lost.

Task	Actions/description
Execute function.	<ol style="list-style-type: none">   Configuration Format. Confirm format: .

Factory settings

The instrument settings can be reset to the factory settings.

Please note: time/date, country settings and counter are not reset.

Task	Actions/description
Execute function.	<ol style="list-style-type: none">   Configuration Factory settings. Confirm reset: .





6.2.6. Audio (only testo 890-2)









To use the function, a headset must be connected (top interface terminal) or the link to a Bluetooth headset must be established.

This function is only available with the view of a frozen or saved image. For these images, voice commentary can be recorded and edited.

Next to the bar display (top), two times are displayed (format mm:ss):

- Left time: current recording or playback time (corresponds to right end of the white recording or playback bar).
- Right time: maximum recording period (60 s).

Task	Actions/description
Open Audio input screen.	<ol style="list-style-type: none">   . or   Audio.

Task	Actions/description
Play back recording.	>  . - The recorded voice commentary is played back from the current playback time.
Start recording/resume recording.	>  . - Recording is started or resumed from the current recording time.
Stop recording/jump to time 00:00.	>  . - During recording: recording is stopped. - When recording is stopped: recording or playback time is set to 00:00.
Delete recording.	>  .
Set playback volume (only for wired headset).	1.  . 2.  (loud) or  (normal) or  (quiet).
Apply entries.	>  .

6.3. Measuring

Important framework conditions

Please observe the following framework conditions in order to obtain significant measurement results.

Humidity measurement:

- Pivot the separate humidity measuring instrument or optional radio humidity probe slightly to shorten the adjustment time. Avoid sources of interference (e.g. exhaled air).

Building thermography, investigating the building shell:

- Considerable temperature difference between inside and outside required (ideal: >15°C / >27°F).

- Consistent weather conditions, no intensive sunlight, no precipitation, no strong wind.

To ensure maximum accuracy, the imager requires an adjustment time of 10 minutes after it is switched on.

-
- **i** When using the super-telephoto lens, if there is a change in the ambient conditions the camera may require an adjustment time of > 10 min.
-

Important settings

Before recording an image, check whether the protection glass option is set correctly to prevent corruption of the measurement results, see Optics, page **60**.

Before saving an image, make sure that it is correctly focussed, manually (see Manually focusing the image, page **31**) or automatically (see Automatically focusing the image, page **32**). Images that are not in focus cannot be corrected retroactively!

To obtain precise measurement values, the emissivity and reflected temperature must be set correctly, see Emissivity, page **43**.

Subsequent adjustment is possible via the PC software, if required.

When humidity is high or the imager is a considerable distance from the object to be measured, atmospheric correction increases measurement accuracy, see Atmospheric correction, page **42**.

When auto-scaling is activated, the colour scale is continuously adjusted to the min.-/max.- values of the current measurement image. This means that the colour assigned to a specific temperature is changing constantly! To be able to compare multiple images based on the assigned colour, scaling must be set manually to fixed values (see Scale manual, page **45**), or must be subsequently adjusted to uniform values using the PC software.

7 Maintaining the product

Changing the rechargeable battery

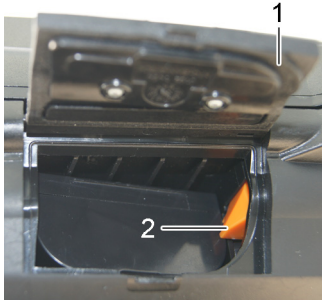

1. Open battery compartment cover (1).
2. Press red lock release button (2).
 - The rechargeable battery is released and sticks out a little from the battery compartment.
3. Pull the rechargeable battery out of the battery compartment.
4. Slide rechargeable battery fully into the battery compartment until it clicks into place.
 - The imager starts automatically.
5. Close the battery compartment cover.

Cleaning the display

- > Clean the display when dirty with a cleaning cloth (e.g. microfibre cloth).

Clean thermal imager

- > If the housing of the thermal imager is dirty, clean it with a damp cloth. Do not use any aggressive cleaning agents or solvents! Weak household cleaning agents and soap suds may be used.

Cleaning lens protection glass

- > Large dust particles can be removed with a clean optical cleaning brush (available in specialized photography shops).
- > Use a lens cleaning cloth for slight contamination. Do not use rubbing alcohol!

8 Tips and assistance

8.1. Questions and answers

Question	Possible causes / solution
Error No memory card inserted! is displayed.	Memory card defective or not inserted. > Check or insert memory card.
Error Memory card full! is displayed.	Insufficient memory present. > Insert new memory card.
Error No lens or Wrong lens! is displayed.	> Check lens > Change lens if necessary.
Information Charging not possible is displayed.	Ambient temperature is outside the permissible range for charging the battery. > Observe permissible ambient temperature.
Error Permissible instrument temperature exceeded! Turn off instrument! is displayed.	1. Switch off thermal imager. 2. Allow instrument to cool down and observe the permissible ambient temperature.
~ is displayed before a value.	Value is outside the measuring range: extended display range with no guarantee of accuracy.
--- or +++ is displayed instead of a value.	Value is outside the measuring range and the extended display range. > Change measurement range.
xxx is displayed instead of a value.	Value cannot be calculated. > Check parameter settings for plausibility.

If we were unable to answer your question, please contact your local dealer or Testo's Customer Service. Refer to the back of this document or website www.testo.com/service-contact for contact details

8.2. Accessories and spare parts

Description	Article no.
Lens protection glass	0554 0289
Additional battery	0554 8852
Fast battery charger	0554 8851
Adhesive emission tape	0554 0051
Process analysis package function (only testo 885-2), image sequence capturing in the instrument and fully radiometric video measurement	0554 8902
SuperResolution function	0554 7806
ISO calibration certificates:	
Calibration points at 0°C, 25°C, 50°C	0520 0489
Calibration points at 0°C, 100°C, 200°C	0520 0490
Freely selectable calibration points in the range 18°C to 250°C	0520 0495
Retrofitting for high temperature	on request from Testo Service
Telephoto lens	on request from Testo Service
Super-telephoto lens	on request from Testo Service
Self-adhesive labels for creating markers for site recognition	available from specialist office supplies stockists. Recommendation: Avery Zweckform L4776

For further accessories and spare parts, please refer to the product catalogues and brochures or look up under www.testo.com

